

PART #	PART NAME	REQ'D	MATERIAL
1	BASE	1	1020 STEEL
2	END BRACKET	2	1020 STEEL
3	CENTER PLATE	1	1020 STEEL
4	HEX HEAD BOLT	2	
5	FLAT HEAD MACHINE SCREW	2	
6	HEX HEAD NUT	2	

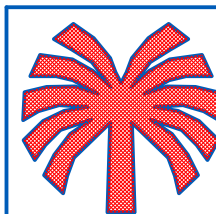
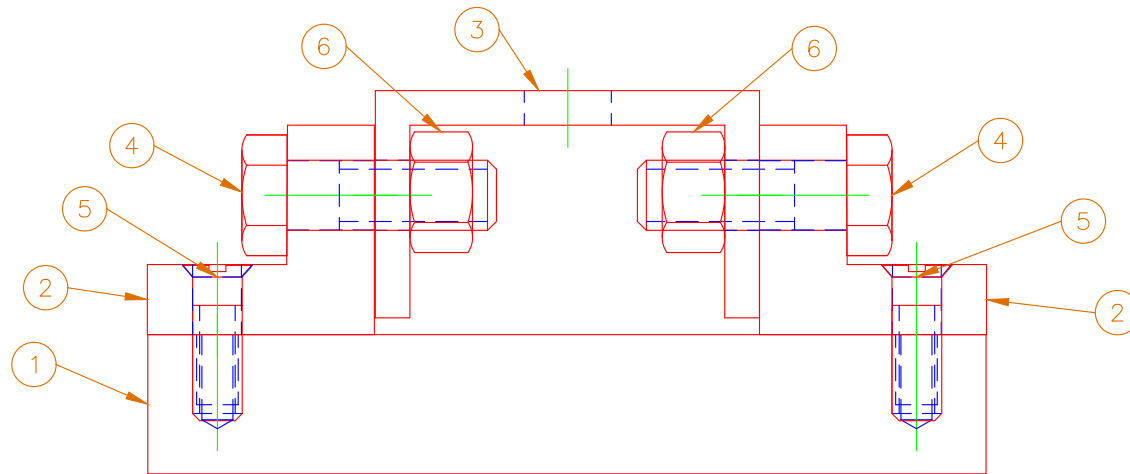

GCC

STUDENT
DUNCAN MAC IVER

SIZE DRAWING
A 101-DRILL JIG

DATE
11/22/25

SCALE INSTRUCTOR
1:2 BRYON JOYCE

COURSE
CAD101

CENTER PLATE

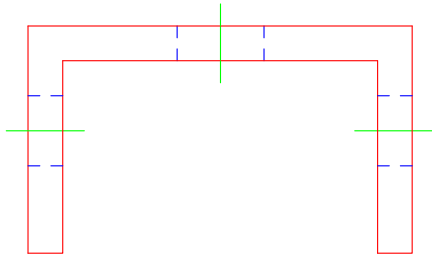

END BRACKET

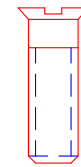
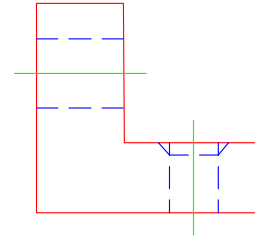

FLAT
HEAD
MACHINE
SCREW

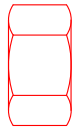

HEX
HEAD
NUT

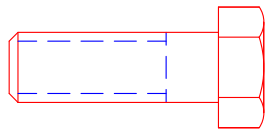

HEX
HEAD
BOLT

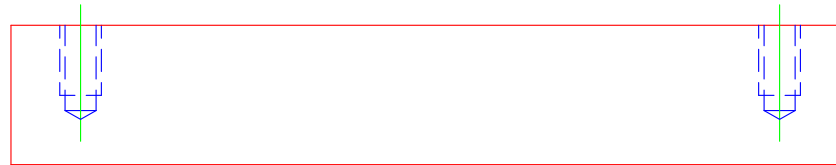

BASE

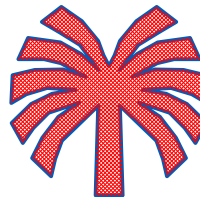

GCC

STUDENT
DUNCAN MAC IVER

SIZE DRAWING
A 101-DRILL JIG PARTS

DATE
11/22/25

SCALE INSTRUCTOR
1:2 BRYON JOYCE

COURSE
CAD101

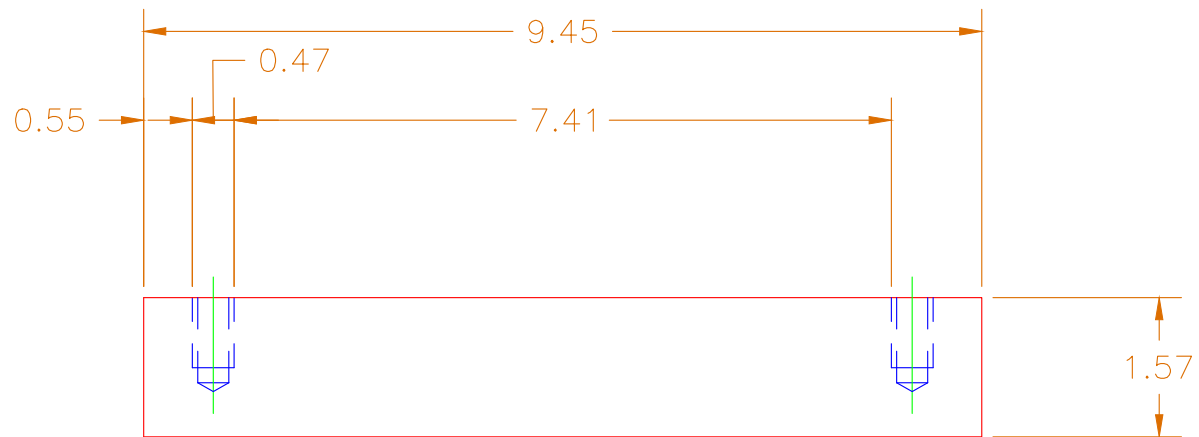

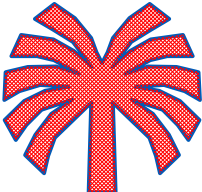
	GCC		
	STUDENT DUNCAN MAC IVER		
	SIZE A	DRAWING 101-BASE	DATE 11/22/25
	SCALE 1:2	INSTRUCTOR BRYON JOYCE	COURSE CAD101

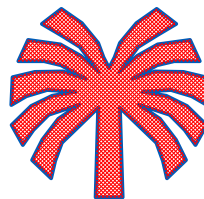
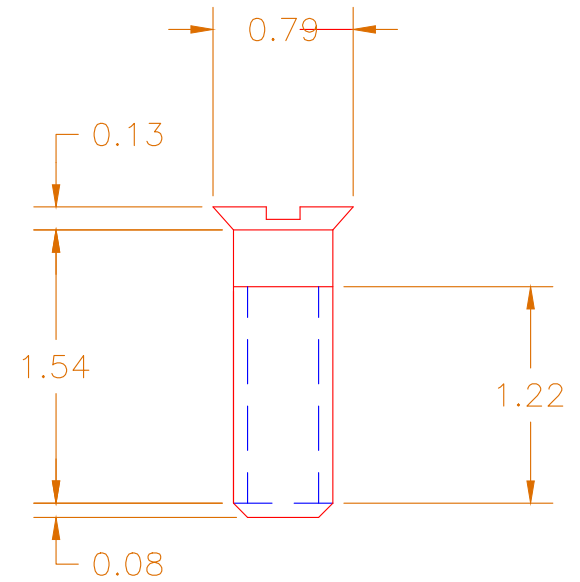
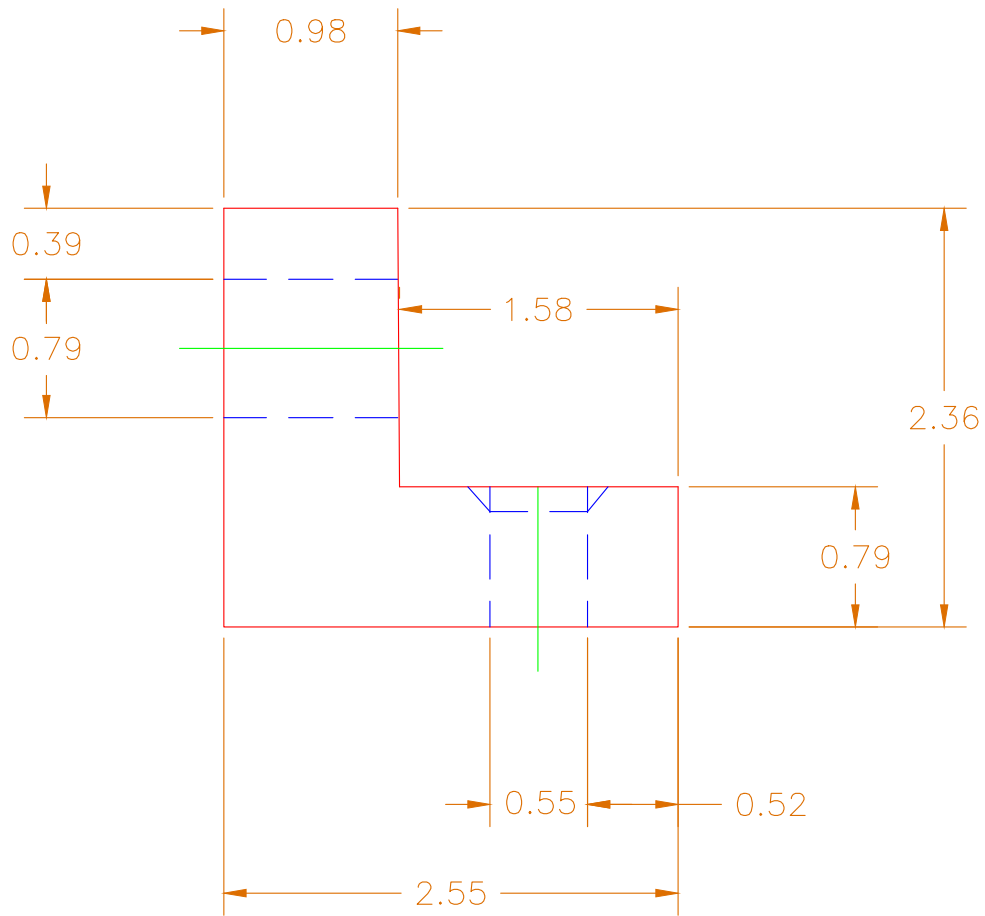

GCC

STUDENT
DUNCAN MAC IVER

SIZE DRAWING DATE
A 101-BRACKET & FLAT HD 11/22/25

SCALE INSTRUCTOR COURSE
1:1 BRYON JOYCE CAD101

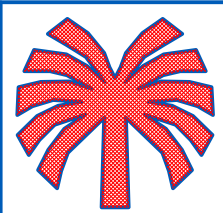
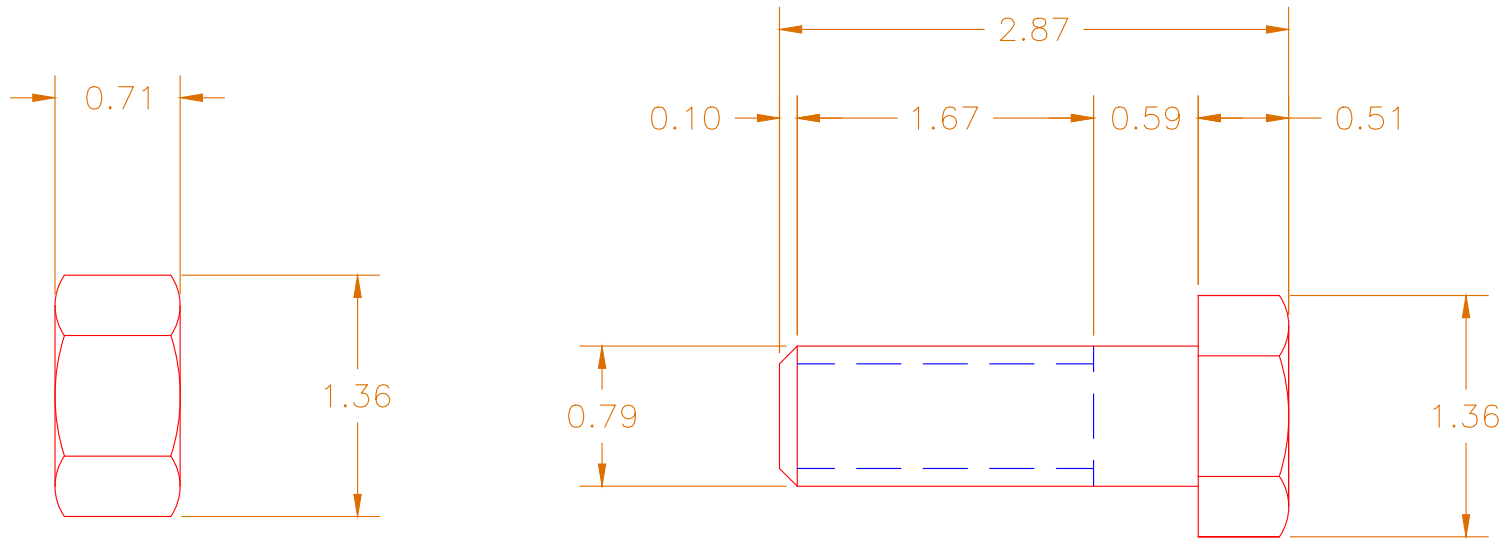

GCC			
STUDENT DUNCAN MAC IVER			
SIZE A	DRAWING 101-HEX HD & BOLT NUT		DATE 11/22/25
SCALE 1:1	INSTRUCTOR BRYON JOYCE		COURSE CAD101

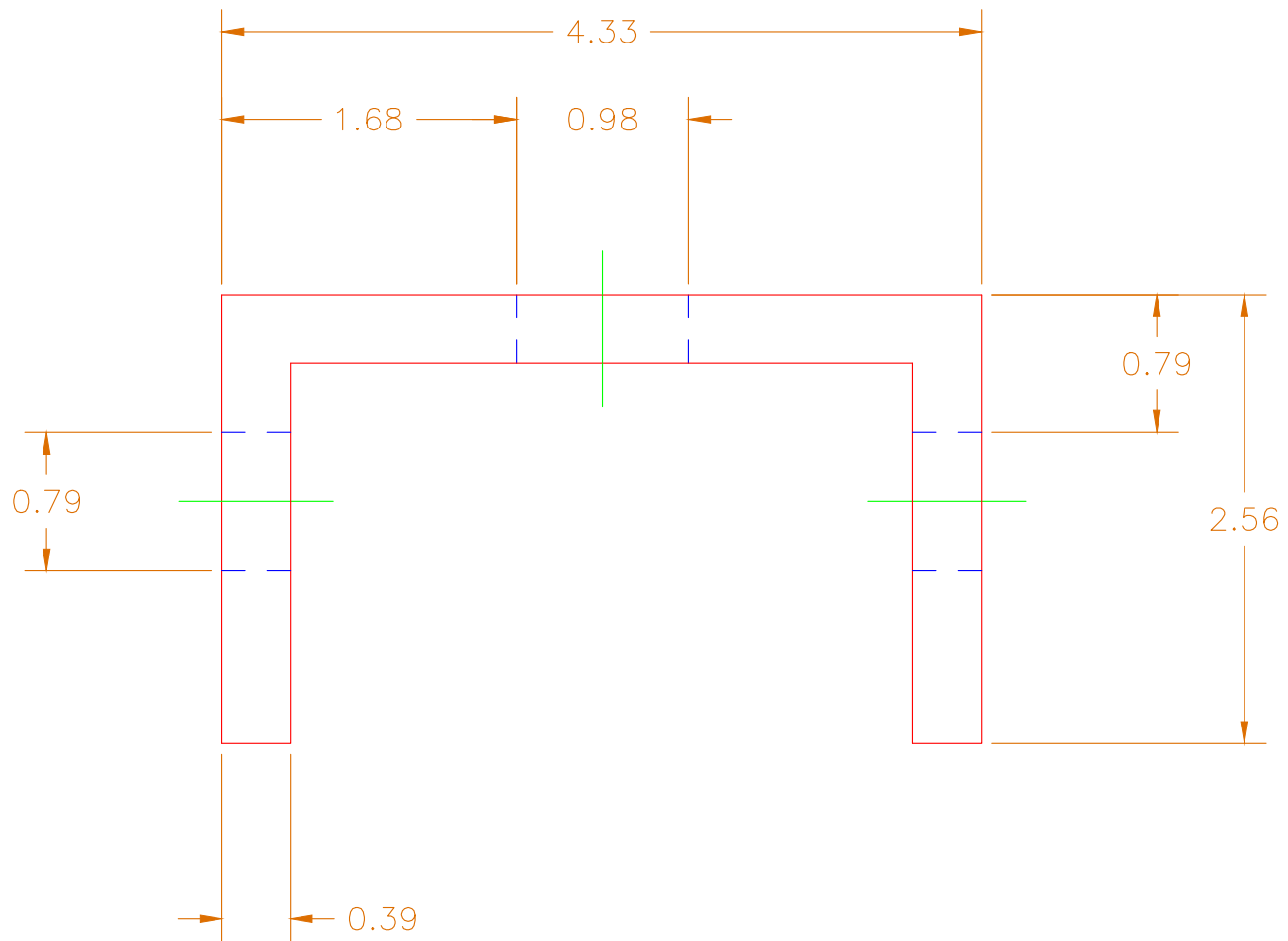

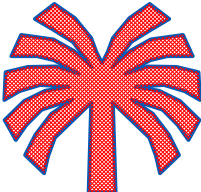
	GCC		
	STUDENT DUNCAN MAC IVER		
	SIZE A	DRAWING 101-CENTER PLATE	DATE 11/22/25
	SCALE 1:1	INSTRUCTOR BRYON JOYCE	COURSE CAD101